

Check weigher

CW-100G-101A

User's manual

(Applicable for MCGS+C01 version)

Contents

1. Summary.....	1
1.1 Product Features	1
1.1.1 Mechanical part	2
1.1.2 Electrical part	2
1.2 Usage Notice.....	2
1.2.1 Precautions	2
2. Product installation	3
2.1 Overall appearance	3
2.2 Mechanical installation.....	4
2.3 Electrical installation	4
2.4 Electrical interface.....	6
2.5 Power supply power.....	10
3. Operation	11
3.1 Operation summary	11
3.2 Basic operation	11
3.2.1 Power-on operation	11
3.2.2 Zero clear operation.....	13
3.2.3 Start up operation	13
3.2.4 Stop operation.....	13
3.2.5 Power off operation	13

3.3	User login	13
3.4	Product selection with New	14
3.4.1	Select product parameters	14
3.4.2	New product parameters.....	15
3.4.3	Modify product parameters.....	18
3.4.4	Delete product parameters.....	19
3.5	Calibration scale	19
3.5.1	The weight calibration scale	20
3.5.2	Dynamic calibration of scale	20
4.	Data viewing	23
4.1	Check the result data.....	23
4.2	Statistics	24
4.3	Alarm information.....	24
4.4	Statistical graph	25
5.	Quantity of switches	26
5.1	I/O I/O testing	26
6.	Working parameters	31
6.1	Working parameter Settings	31
7.	Communication	36
7.1	Communication parameters	36
7.1.1	Serial port communication.....	38

7.1.2	Network port communication.....	38
7.1.3	MAC address	39
7.2	The Modbus register communication address is defined.....	39
7.3	Print content	45
7.4	Set the parameters of the servo driver.....	46
8.	Program upgrade	47
9.	Size.....	48
9.1	Outline size drawing (unit: mm).....	48
10.	Equipment repair and maintenance	49
10.1	Maintenance of motors	49
10.1.1	Routine maintenance	49
10.1.2	Regular maintenance	49
10.1.3	Precautions	49
10.2	Check the failure cause and treatment method of weight scale .	49
10.2.1	No display on the touch screen.....	49
10.2.2	Data pulsation large, abnormal fluctuation	49
10.2.3	The display is always zero	50
10.2.4	Abnormal data display.....	50
10.2.5	Busy alarm	50
10.2.6	Packaging error	50
10.2.7	Continuous nonconformity alarm	51

10.2.8 Excess plugging time	51
10.2.9 Below the minimum sampling time	51
10.2.10 Super maximum sampling time	51
10.2.11 Overload motor load limit.....	51
10.2.12 Automatic zeroing failed	51

Shenzhen General Measure Technology Co., Ltd. All rights reserved.
Without the permission of Shenzhen General Measure Technology Co., Ltd., no unit or individual may copy, disseminate, transcribe or translate into other language versions in any form or by any means.

Due to the continuous improvement and update of our products, we reserve the right to modify this manual at any time without prior notice. For this purpose, please visit our website frequently for timely information.

The company's Web address <http://www.gmweighing.com>

1. Summary

CW-100G checkweigher is an industrial automatic checkweigher with high speed, high precision developed by our company to meet the changing technological update.

Full touch screen makes CW-100G checkweigher easy to operate, external expansion of IO input and output and external serial port communication to achieve multi-point control, monitoring and remote control of the product.

1.1 Product Features

Product parameters;

Model number	CW-100G
Power supply	AC220V±10%, 50/60Hz, 350W
Weighing range	5 to 100g
Accuracy of weight check	Plus or minus 0.3 g
Weight checking speed	180 pieces/min
Conveyor belt speed	15 to 60 m/min
Belt size	250mm*100mm
Center distance of drum shaft	250mm
Table height	830 (±50mm)
Operating temperature	0 to 45°C
Maximum humidity	90% R.H non-dew forming
Ultimate load	The instantaneous ultimate load shall not exceed 200g

Note; Scale stands are strictly prohibited from being used over the range.

1.1.1 Mechanical part

1. The servo driver is used as the motor driving device to ensure the stability and adjustability of the speed in the process of weight checking.
2. Double photoelectric mode more accurately determine the object up and down the weighing platform, improve the accuracy and efficiency of weight detection.
3. Scale height adjustment range is larger, convenient for customers to choose to use.
4. Mechanical modular design makes transportation and maintenance more convenient and application adaptability stronger.

1.1.2 Electrical part

1. Simple wiring, external only need to access the power cord; The internal use of different specifications pin plug terminal block, wiring is convenient and will not make mistakes.
2. Touch screen operation interface optimization, product parameter setting is simple and the main interface content is richer.
3. The three-color indicator shows qualified (green), out-of-tolerance (red), under tolerance (yellow), and the working state of the inspection weight is clear at a glance. Buzzer user can define the alarm mode.
4. The new algorithm is adopted in the process of weight inspection, and the high precision can be guaranteed in the process of high-speed weighing.
5. Optimize user login and logout function, without tedious operation and effectively prevent others from disoperation.

1.2 Usage Notice

1.2.1 Precautions

1. Do not perform mechanical or electrical maintenance while live, do not place tools on the scale, and do not perform welding operations on the scale.
2. The installation site must ensure the ground level, after installation through the foundation adjustment, ensure that the weighing table level, tilt does not exceed 0.5 degrees, away from the vibration source.
3. Make sure the equipment is safely grounded and there is no strong electricity or magnetic field interference nearby.
4. Do a good job of fire prevention, avoid direct sunlight to check the weighing table and relatively strong air flow (outdoor air, fan and air conditioning outlet is directly against the weighing table).
5. Should avoid squeezing, stepping on the scale platform, handling should first fixed scale, installed sensor limit to prevent damage to the sensor, prohibit the direct handling of the scale platform to move.

2. Product installation

2.1 Overall appearance

The product appearance is shown in Figure 2-1 below.



Figure 2-1 Overall appearance of the product

Serial number	Name	Introduction
1	Peduncle	Prevent sliding and vibration of the weighing scale, and adjust the level of the weighing table.
2	Conveyor belt	The conveying end of the weighing platform on the object
3	Weighing platform	Weighing platform for the measured object
4	indicator light	More intuitive display of the weight inspection results, allowing the status of the results to be seen from a distance.

5	Electric control panel	Control the weight inspection process and connect external devices
6	Windshield	Reduce the impact of environmental factors such as on-site airflow on weighing
7	Remove the end belt	Unqualified products will be eliminated at this location
8	Pressure relief valve	Adjusting air pressure

2.2 Mechanical installation

Place the checkweigher at the installation place and remove the sensor protection device; Adjust the levelness of the checkweigher, and the inclination shall not exceed 0.5 degree; Fix the footing of the checkweigher, the stainless steel footing contacts the ground smoothly, and lock the screws of the footing to ensure the stability of the checkweigher.

Adjust the distance between the check weighing platform and the front and rear end conveying mechanism is 9 ~ 11mm, and the check weighing platform shall not be in contact with other equipment. If the front and back end conveying mechanism is not equal to the height, it is necessary to add the oblique conveying mechanism on one side, and add the horizontal conveying mechanism connection on the side of the oblique mechanism (to leave a gap) to check the weight scale platform, to ensure that the check weight scale platform level and the height of the front and back end conveying mechanism.

The electric control box can be arbitrarily installed on the left and right sides of the checkweigher to facilitate the operation of the production process.

2.3 Electrical installation

The power supply is inserted into the three-hole socket with ground or connected to the power supply equipment such as the electric gas cabinet according to the line mark.

Any wiring and disconnecting operation can only be carried out after power off. After the operation is completed, check before power on.

2. The serial port is fixed to RS485 communication, where the 485(A) pair should be connected to 485(A) or 485(+), and the 485(B) pair should be connected to 485(B) or 485(-).

3. The switching quantity input point is valid at low level (DC0V) and does not allow access to high voltage or alternating current.

4. Switching quantity output point access relay coil for intermediate control, so the other end of the relay can access DC or AC power supply switching quantity.

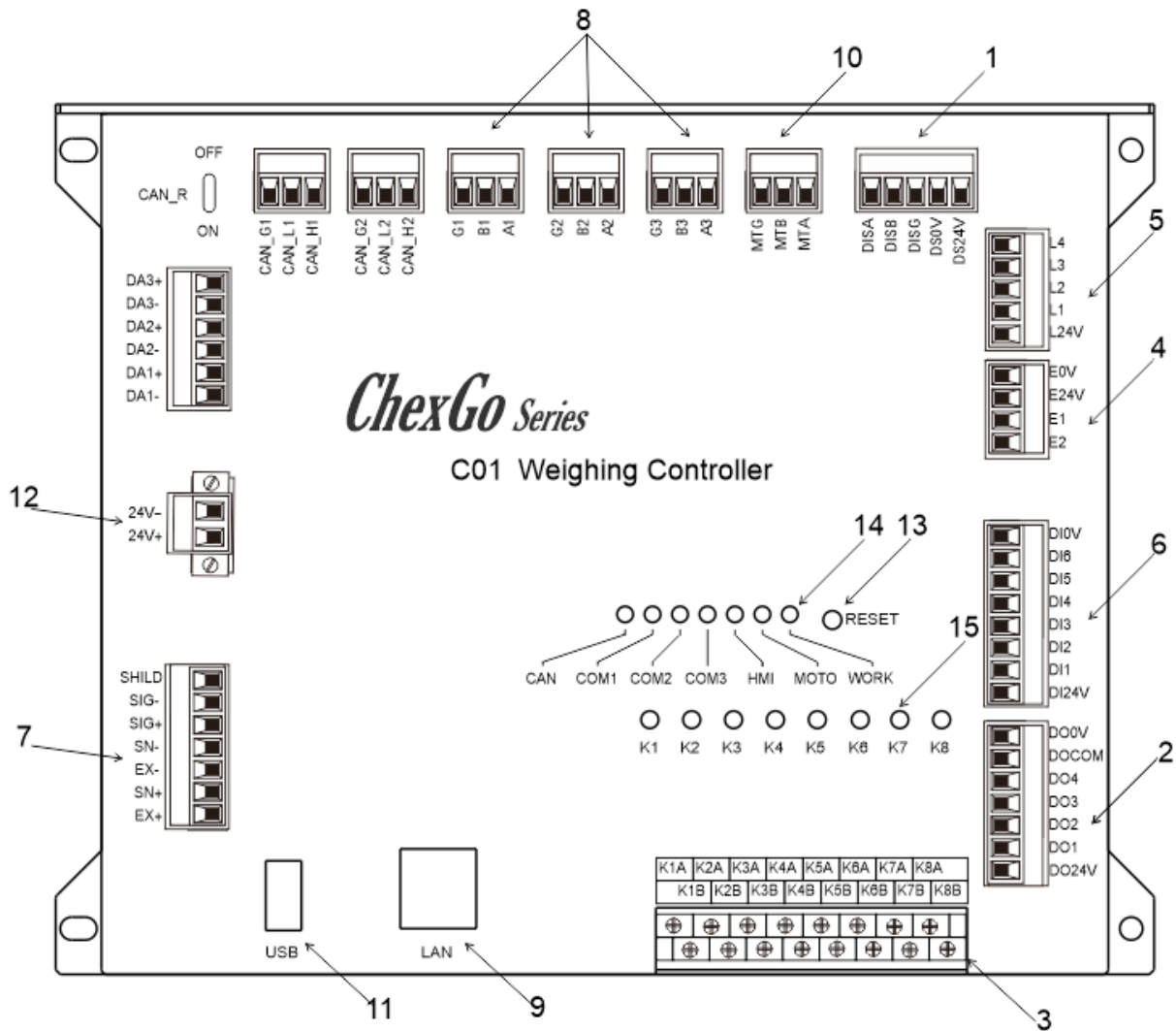

Figure 2-2 Control panel of checkweigher

Serial number	Function
1	Touch screen communication jack
2	External custom outlet OUT1-OUT4
3	External custom output relay K1-K8
4	Detect the photoelectric sensor wiring terminals
5	Alarm light wiring terminals
6	Custom input ports 1-6 externally

7	Sensor terminal
8	External RS-485 communication jack
9	External TCP/IP communication network port
10	Inverter communication jack
11	External USB data interface
12	24V power terminal
13	Reset key
14	Communication status indicator
15	Output relay status indicator light

2.4 Electrical interface

Photoelectric sensor (already wired at factory):

E24V: photoelectric sensor DC24V+.

E0V: photoelectric sensor DC24V-.

E1: Signal input of photoelectric sensor for loading of checkweigher.

E2: Check the output photoelectric sensor signal input of the weight balance.

Alarm light (has been connected when leaving the factory):

L24V: Alarm light DC24V+, maximum output power 2VA.

L1: Buzzer.

L2: When the detection result is out of tolerance, the low output is valid until the next check begins.

L3: When the test result is qualified, the low output is valid until the next check begins.

L4: When the detection result is inferior, the low level output is effective until the next check starts.

Input (function can be customized, onsite connection according to actual demand):

DI1: running input. In the stopped state, the input is valid and the system enters the running state.

DI2: Stop input. In the running state, the input is valid and the system enters the stop state.

DI3: clear the alarm. When the system generates an alarm, change the input to be effective and the alarm will be cleared.

DI4: out-of-tolerance elimination is completed. When the input is valid, the output of out-of-tolerance elimination is invalid.

DI5: Under error culling is complete, under error culling output is invalid when this input is valid.

DI6: continuous packet detection. This input signal is given by the photoelectric sensor installed on the front conveyor line of the checkweigher and used in conjunction with the busy stop output to control the start and stop of the front conveyor line of the checkweigher. When there is an object being detected on the weighing platform and the signal is effective, the busy stop output is effective.

DI0V: switching quantity power supply DC24V-.

DI24V: Switching quantity power supply DC24V+.

4 transistor outlet (function can be customized, on-site according to the actual demand connection):

DO1: No definition.

DO2: undefined.

DO3: undefined.

DO4: undefined.

DO0V: switching quantity supply power DC24V-.

DO24V: switch quantity power supply DC24V+.

DOCOM: switch quantity common end.

Sensor (already connected at factory):

EX+: Power positive, SN+: induction positive, EX- : power negative, SN- : induction negative, SG+: signal positive, SG- : signal negative.

Motor speed control communication interface (RS485):

MT A: RS485 communication A.

MT B: RS485 Communications B.

MT G: RS485 Communication (GND).

8-way relay outlet (function can be customized, on-site connection according to actual demand):

K1: defined as operation. When the system is in operation state, the relay output is closed, and K1A and K1B are switched on. Used to control the start and stop of frequency converter.

K2: defined as stop. When the system is in the stopped state, the relay output closes and K2A and K2B are switched on. This definition is the factory default setting and can be modified according to the actual needs.

K3: defined as out of tolerance elimination, the product test result is out of tolerance, and within the range of out of tolerance elimination duration, the relay output is closed, K3A, K3B switched on. This definition is the factory default setting, and can be modified according to the actual demand.

K4: defined as under error elimination, product detection result is under error, and within the range of under error elimination duration, the relay output is closed, K4A, K4B on. This definition is the default setting of the factory, and can be modified according to the actual demand.

K5: defined as alarm. When alarm occurs in the system, the output of the relay is closed and K5A and K5B are switched on. This definition is the factory default setting, and can be modified according to the actual demand.

K6: defined as batch completion, after the completion of the product test batch, the relay output is closed, K6A, K6B on. This definition is the factory default setting, and can be modified according to the actual demand.

K7: defined as qualified indication, after the product test is qualified, the relay output is closed, K7A, K7B on. This definition is the factory default setting, and can be modified according to the actual demand.

K8: defined as rejection of unqualified. When unqualified is detected, the output of the relay is closed, and K8A and K8B are switched on. This definition is the factory default setting, and can be modified according to the actual demand.

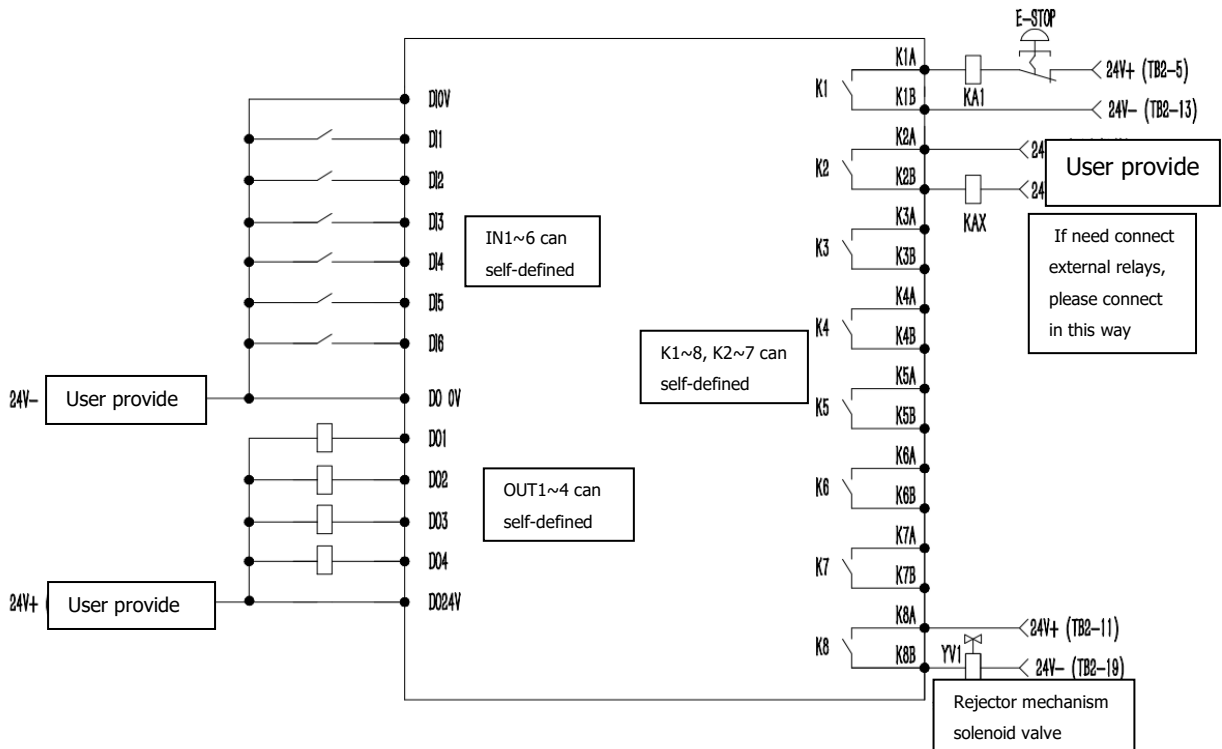

Figure 2-3 Schematic diagram of inlet and outlet connections

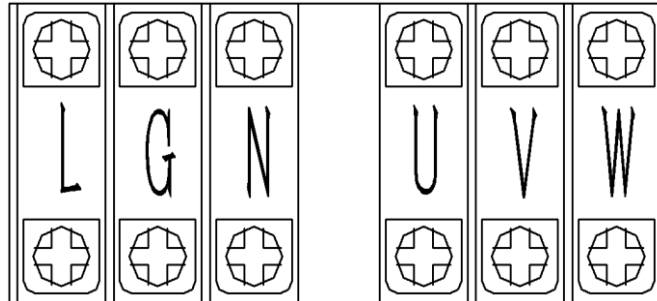

Figure 2-4 Power supply and motor interface diagram

Figure 2-4 shows the power supply and motor interface diagram, defined as follows:

External power supply (already connected at factory):

L: external AC power live wire.

G: external AC power ground cable.

N: neutral wire of external AC power supply.

Frequency converter output power supply (factory has been connected):

U: Corresponding to the U terminal connected to the motor.

V: corresponds to connect the motor V terminal.

W: corresponds to connect the motor W terminal.

Note: L, N and G are the external AC power supply, and U, V and W are the output power supply of the inverter to power the motor. These two groups of power supplies have been connected before delivery. If the frequency converter or motor needs to be reconnected in the subsequent use and maintenance process, please be sure to connect correctly according to the instructions, and remember not to connect it backwards, otherwise it will cause damage to the frequency converter.

2.5 Power supply power

AC220V \pm 10%, 50/60Hz, 350W.

3. Operation

3.1 Operation summary

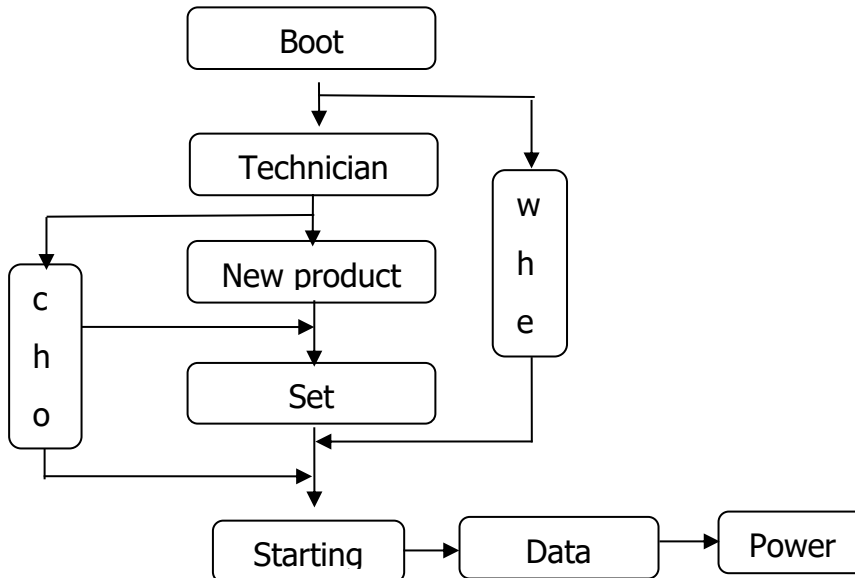

Figure 3-1 Procedure

3.2 Basic operation

The main interface of weight inspection is used for daily production, which is used to start and stop the weight inspection belt, enter the relevant parameter interface and display the basic information of the tested product and the weight inspection result.

3.2.1 Power-on operation

Power on and turn the knob switch to the "1" position. The power-on touch screen of the electric cabinet displays the initialization interface. At the top of the interface are USB insert mark, check scale model and time display; The black display area is the name of the current production inspection product, the weight display area, the weight unit display area and the weight check scale status display area; In the middle is the current setting of weight checking speed, the current actual weight checking speed and the display statistics of weight checking results; At the bottom are the function keys of the operation of the weight check scale and the parameters related to the weight check.

- Correct time parameters can effectively help users check the production inspection results, relevant production parameter changes and alarm information, help to improve the production pass rate and production speed and reduce production consumption.
- The weight display area of the checkweigher displays the real-time weight value in the stopped state, and displays the weight test result in the running state until the next object is effective.

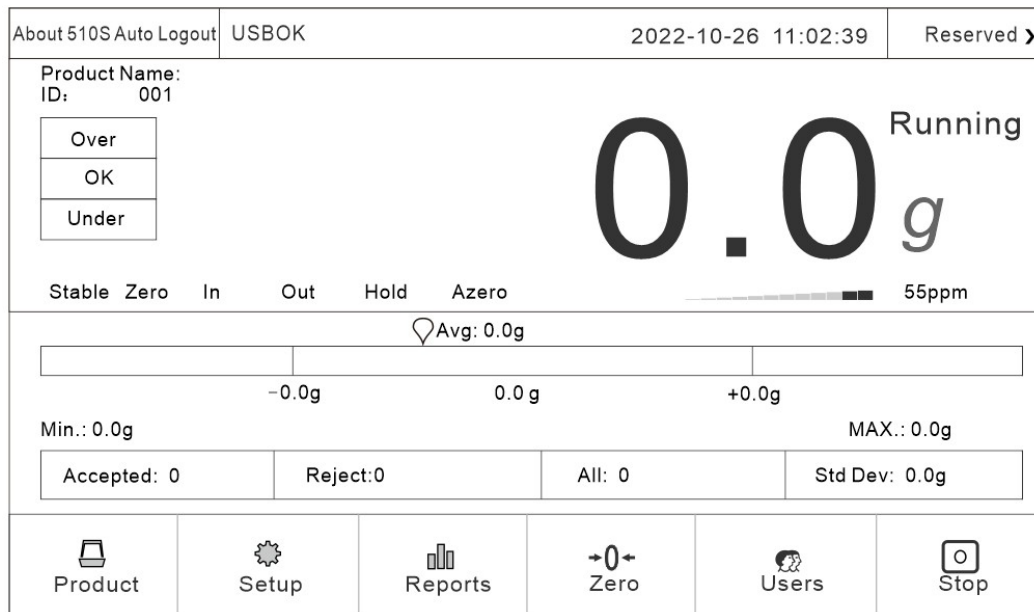









Figure 3-4 Power-on initialization interface

Button and operation frame operation instructions (applicable to all operation interfaces of the device) :

1.  **Product** Click this button to enter the interface of creating products and setting product parameters.
2.  **Setup** Click this button to enter the parameter setting interface.
3.  **Reports** Click this button to enter the data interface to view the relevant check data.
4.  **Zero** Click this button to clear zero.
5.  **Users** Click this button for user management operations.
6.  **Stop** Click this button to start and stop the device.
7. **0 g >** Click this type of action box to modify the value of this item.
8. **192** Click the action box to modify the value of this item.
9. **None** Click this type of action box to select Settings for this definition.
10. **Change** Click this type of action box to perform the corresponding operation.

11.  Click this type of action box to open and close the corresponding function Settings.

3.2.2 Zero clear operation

If the touch screen displays the real-time weight value of the checkweigher in the stopped state is not zero (zero indicates the off state), click "Clear zero" to clear the weighing platform, so that the real-time weight value is displayed as zero, and then the zero indicates the on state.(It can be operated only in the stopped state).

If the weight check scale shows that the weight is unchanged, the stable identifier bit is on; otherwise, the stable identifier bit is off (the stable identifier bit is only related to the weight state, and has nothing to do with the operation of the checkweigher and the size of the weight value).

3.2.3 Start up operation

Click "Start" on the touch screen to start the weight checking scale, and the weight checking motor drives the weight checking belt to rotate. At this time, the operation label on the touch screen is "Running", and the weight checking operation can start.

3.2.4 Stop operation

Click "Stop" on the touch screen to stop the weight inspection belt and end the weight inspection process. At this time, the operation label on the touch screen is "Stopped".

3.2.5 Power off operation

Turn knob switch to "0" position, touch screen off, disconnect power.The above operations can only be performed when there is no weight product on the checkweigher.

3.3 User login

Under the touch screen initial interface, click "Product" or "Settings" to pop up the password login box, select the user to enter the corresponding password and click "Confirm" to log in.The initial passwords of the operator and administrator are written in the user description.

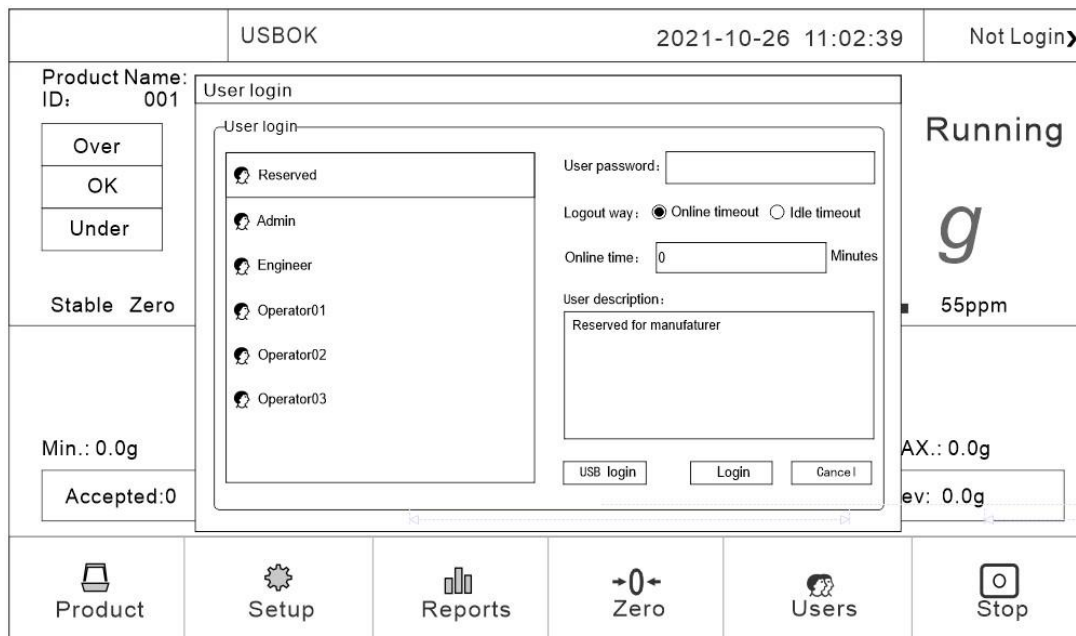

Figure 3-5 Password input box

3.4 Product selection with New

Product Setting		2022-10-26 11:02:39				Reserved >			
ID	Product Name	Passing Speed	Standard Weight	Hi Limit	Lo Limit	Curr.Product ID: 001 Add Product Select Product Delete Product			
001		000	0	0	0				
001		000	0	0	0				
001		000	0	0	0				
001		000	0	0	0				
001		000	0	0	0				
001		000	0	0	0				
001		000	0	0	0				
001		000	0	0	0				
001		000	0	0	0				
001		000	0	0	0				
001		000	0	0	0				
001		000	0	0	0				
001		000	0	0	0				
-01-	-02-	-03-	-04-	-05-	-06-	-07-	-08-	-09-	-10-
Product List		Product Parameter		Dynamic Calibration		EXIT			

Figure 3-6 Product list

3.4.1 Select product parameters

Click "Product" under the main interface to enter the product list interface. First, click the product to be checked in the product list, then click "Select Product" to select the product, click "Exit" to go to the main interface and click "Start" to check the product.

- After the product is successfully selected, the current number will be displayed as the number of the selected product in the upper right corner of the product list page.
- The new product number cannot be selected during the operation of the weight check scale; By default, the product number selected by the checkweigher before exit (stop operation or the checkweigher power off).

3.4.2 New product parameters

On the product list page, click "Add Product" to jump to the "Product Parameters" interface to add a new product parameter. The new product number will be added to the existing product in sequence. You do not need to select the product number. For details, refer to "Operation Instructions on Buttons and Operation Frames" in Section 3.3.2.

★ The new product number cannot be added during the operation of the weight check scale; The newly added product parameter values are the default initial values of the system, which need to be set according to the actual product parameters and production requirements.

Product Setting		Product Name: ID: 001		0.0 ^{Stopped} g 0ppm		Reserved >	
? Help						2021-10-26 10:02:26	
Product ID		1		Passing Speed		0ppm >	
Product Name		<input type="text"/>		Belt Speed		0.00m/min	
Standard Weight		0.0g >		Weight Correction Factor		1456 >	
Hi Limit		0.0g >		Over Rejector Distance		0 mm >	
Lo Limit		0.0g >		Over Rejector Operating Time		0.000 S >	
Tare		0.0g >		Under Rejector Distance		0 mm >	
Unqualified Rejector Distance		0 mm >		Under Rejector Operating Time		0.000 S >	
Unqualified Rejector Operation Time		0.000 S >				Next Page >	
Product List		Product Parameter		Dynamic Calibration		EXIT	

Figure 3-7 Product parameters screen Example

Description of product parameters:

Name	Instructions
Product number	Number of the product under inspection
Passing Speed	The speed at which the current weight checking device detects the product

Product name	Name of the product under inspection
Belt speed	Weigh the speed at which the belt is running
Standard weight	The standard weight of the product to be checked
Upper limit	In the process of weight inspection, if the weighing value is greater than the target value + the upper limit value, it will be judged as out of tolerance
Lower limit value	In the process of weight inspection, if the weighing value is less than the target value-lower limit value, it will be judged as undererror
Tare weight	The weight of the item's outer packaging
Qualified culling distance	The distance traveled by the product from the end of the scale to the start of the qualified culling mechanism
Duration of qualified culling	The duration of the qualifying cull mechanism's action
Out-of-tolerance culling distance	The distance traveled by the product from the end of the scale to the start of the offset removal mechanism
Underweight culling distance	The distance traveled by the product from the end of the scale to the start of the underbalance removal mechanism
The out-of-tolerance culling action time	The duration of the kill mechanism's action
Undershoot culling action time	The duration of the underkill operation
Unqualified culling distance	The distance traveled from the end of the scale to the nonconforming product after the start of the removal mechanism
The time of the unqualified culling action	The continuous action time of the rejection mechanism for nonconforming products (including out-of-error + undererror)
Correction factor	Standard no correction is 1000. Correction factor = $1000 + (\text{actual weight} - \text{test weight result}) / \text{min indexing}$. That is, if the weight test result is light, the correction factor is the number greater than 1000, if the weight test result is heavy, the correction factor is the number less than 1000

Total lot	Total number of pieces of heavy product inspected
Qualified batches	Number of eligible batches of products
Sampling starting percentage	The sampling data to this percentage is discarded after the object is placed on the scale
Percentage used for sampling	Data that is consistently used as a percentage from the start of sampling is used to calculate the weight check result
Dynamic zeroing filter grade	Filtering parameters in the weighing process
Dynamic clearing stability range	When the belt is running, within the stability determination time, the weight variation range is judged to be stable within this setting value, and only when it is stable can dynamic zeroing be allowed
Dynamic zeroing and stabilizing time	When the belt is running, within this setting value, the range of weight variation is judged as the stability of the scale platform within the range of dynamic zero clearance stability. Only when the stability allows the dynamic zero clearance
Maximum sampling time	Maximum sampling time during weighing
Cont.ZERO Failure Alarm Threshold	How many times did the weighing platform fail to reset dynamically during the weighing process
Number of Averaging Samples	During servo control, the average value of the set number of products is compared with the user set value, and the difference between them is used as the basis of control. When it is 0, the filling servo function is not used
Plus frequency	Pulse frequency value of servo motor
Skip Samples	It is equivalent to the number of objects from the charging machine to the photoelectric switch of the weighing scale. It also refers to the number of products passed before the next correction
Diff in Gram	This setting is the adjusted weight corresponding to each correction pulse
Target Weight	Equivalent to the target value of package inspection weight
Tendency Max.Limit	When the weight is higher than this value, it will not participate in the average value calculation and will generate an alarm

Tendency Min.Limit	When the weight is lower than this value, it will not participate in the average value calculation and will generate an alarm
Servo motor dead zone	If the absolute value of weight error is lower than this value, it will not be corrected
Maximun servo modulation	Refers to the maximum allowable modulation correction
Tendency Max.Limit Alarm&Stop	Eliminate servo upper limit alarm shutdown
Tendency Min.Limit Alarm&Stop	Eliminate servo lower limit alarm shutdown
Servo longtime Alarm&Stop	Alarm shutdown not corrected in time

3.4.3 Modify product parameters

On the Product list page, select the product whose parameters you want to modify from the product list and click "Product Parameters" to enter the product parameters interface to modify the selected product parameters (the newly added product directly jumps to the product parameters interface).

- The standard weight refers to the weight of the product to be checked, and the upper and lower limit is the allowable deviation value of qualified product; If it is not necessary to calculate the packaging weight of the product, the outer packaging weight of the product can be written into the tare weight column, and the net weight should be filled in the standard weight column.
- The product number is automatically generated by the system; The linear speed of the belt is calculated from the detection speed, and changes with the change of the detection speed. It cannot be filled in (the linear speed of the belt should be consistent with the linear speed of the front and rear end conveying mechanism).
- The compensation weight difference value is calculated by dynamic calibration. Under normal circumstances, manual change is prohibited to prevent deviation between the product weight and the actual weight.
- When filling in the product parameters, attention should be paid to its value range. Generally, if it is lower than the lower limit of the parameter range, the parameter value will remain unchanged; if it is higher than the upper limit of the parameter range, the upper limit of the parameter range will be written by default.
- The definition of weight checking speed, belt speed and correction coefficient is described in detail on the help interface of product parameters. If necessary, you can click "Help" to view.

3.4.4 Delete product parameters

On the product list page, select the product to be deleted and click "Delete Product" to delete the product. After deleting the product, the following product parameters will move forward in order, and the product number will move forward. The product cannot be deleted during the operation of the weight check scale; In order to prevent product parameters from being incorrectly deleted, the product name should be set reasonably when setting product parameters.

3.5 Calibration scale

In order to ensure the correct weight of the checkweigher and the linearity of the weight change, each checkweigher needs to carry out weight calibration and dynamic calibration. For specific operation methods, please refer to "Operation Instructions on Buttons and Operation Frames" in section 3.3.2.

Product Setting	USBOK	2021-10-26 11:02:39	Reserved >
Product Name: ID: 001	<div style="font-size: 48px; font-weight: bold;">0.0</div> <div style="font-size: 24px; font-weight: bold;">g</div>		Static Weight Calibration Stopped
Stable Zero In Out Hold Azero	 55ppm		
Current mV: 0.000mV	Step 1: Clear platform, then Last Empty Platform's mV: 0.000mV	<input type="button" value="Clibration
Empty Platform"/>	
<input type="text"/>	Step 2: Put the Standard Weight in the middle of the platform, and input the weight	<input type="text" value="0.000"/> g	
Load's mV: 0.000mV	Step 3: Press the button to calbrate	<input type="button" value="Weight
Calibration"/>	
Work Para.	I/O	Static Weight Calibration	Belt Speed Calibration
		System Info.	EXIT

Figure 3-11 shows an example of the weight calibration interface

Description of static calibration parameters:

Name	Instructions
Calibrate the empty scale table	Eliminate external interference, the scale table at zero and stable, can be clicked
Calibrate the scale weight	Enter the weight of the calibration weight

The weight calibration scale	Put the weight on and after entering the weight of the weight, click
Current voltage value	The current voltage value of the sensor
Empty scale voltage value	The voltage value of the sensor when the top of the scale is emptied
Weight voltage value	The voltage value of the sensor after placing the weight

3.5.1 The weight calibration scale

In the setting page, click "Static calibration" to enter the interface of weight calibration, follow the steps on the touch screen to calibrate the scale, and click "Exit" to return to the main interface after the calibration is completed. For specific operation methods, please refer to "Operation Instructions on Buttons and Operation Frames" in Section 3.3.2.

- During calibration, ensure that the checkweigher is in the stopped state; otherwise, the interface of the checkweigher cannot be entered; Calibration should ensure that there is no item on the weighing platform, no vibration on the weighing platform, and no relatively strong air flow around the checkweigher.
- When the weighing platform is empty, ensure that the weighing platform is at zero position and stable. Otherwise, please eliminate interference and click "Calibrate the weighing platform". The second step can only be carried out when the touch screen indicator is 0 and the stability sign is lit.
- When placing the weight, try to avoid the weight hitting the surface of the weighing platform. Enter the correct weight into the weight box of the weighing platform, otherwise it will lead to inaccurate calibration scale or calibration failure (the weight of the weighing platform should be greater than the product weight and not exceed the maximum range of the checkweigher).
- If the calibration fails, please check whether the scale is stable and whether the sensor is interfered by the outside world or whether the scale is in contact with other equipment, and re-calibrate after troubleshooting.

3.5.2 Dynamic calibration of scale

On the product page, click "Dynamic calibration" to enter the dynamic calibration interface, and perform dynamic calibration according to the text prompts. When completed, relevant parameters will be automatically calculated and generated and product parameters will be written. Click "Exit" to return to the main interface after completion of calibration. For details, please refer to Section 3.3.2 "Operation Instructions for Buttons and Operation Frames".

Product Setting	? Help	2021-10-26 11:02:39	Reserved >
Product Name: ID: 001		Dynamic Calibration	
Stable Zero In Out Hold Azero		0.0 g	
		Stopped 55ppm	
Step 1: Clear platform, then		<input type="button" value="Zero"/>	Max. Weight: 0g
Step 2: Put the standard product in the middle of the platform and press		<input type="button" value="Getting Static Weight"/>	Avg. Weight: 0g
Step 3: Use the same tested product,		<input type="text" value="0"/> g	Min. Weight: 0g
Run <input type="text" value="00"/> Times!		<input type="button" value="Start"/>	Correction Factor: 0
Work Para.	I/O	Static Weight Calibration	Max. Weight: 0g Avg. Weight: 0g Min. Weight: 0g Correction Factor: 0
		Belt Speed Calibration	System Info. EXIT

Figure 3-12 Dynamic calibration screen example

Description of dynamic calibration parameters:

Name	Instructions
Zeroing	Clear the current weight value to zero
Get the weight	Stop the belt running and put the test material on after the static weight value shown
Dynamic calibration times	The number of repeated runs of dynamic calibration. The default is ten, and no less than five are recommended
Start up	The belt will run, and after the statically weighed object has passed, it should be moved back to the front stage, repeatedly running dynamically, and the controller will automatically record the dynamic weight. General dynamic calibration ten times, the number of dynamic calibration to check the weight scale will automatically stop
Maximum weight	The maximum value of the weight check result during dynamic calibration
Average weight	During dynamic calibration, the average weight of each check will be updated after the number of dynamic calibration is completed

Correction factor	<p>The standard value is 1000. After the number of dynamic calibration is completed, the controller will automatically calculate this value according to the dynamic result and static weight.</p> <p>If it is not convenient for dynamic calibration, you need to enter this value manually, which can be set in the product parameter interface, and fill in the size of the value refer to the method in the dynamic calibration parameter help interface</p>
-------------------	--

- Calibration must ensure that the check scale in the stopped state, otherwise can not enter the dynamic calibration interface;When calibrating, ensure that there is no item on the scale, no vibration on the scale, and no relatively strong air flow around the scale.
- When the weighing platform is empty, it should be ensured that the weighing platform is at zero position and stable, otherwise, please eliminate external interference and carry out "zero clearing" operation.
- When placing the product, the product should avoid hitting the surface of the weighing platform. Only after the weight is stable can you click "Obtain static weight";If the product has a gross weight value, please set the gross weight value first before dynamic calibration.
- The initial value of learning times defaults to 10. If the learning results are poor in accuracy, you can appropriately increase the number of learning times;If the production requirement is not high, the learning times can be appropriately reduced to improve the learning speed;External interference should be avoided in the learning process, and the system will automatically save the learning results and display them after the completion of learning.
- The change of product detection speed requires dynamic calibration again.
- The principle of dynamic calibration, attention to implementation and alternative methods are introduced in detail in the interface of dynamic calibration parameter help. If necessary, you can click Help to view.

4.2 Statistics

Click "Statistics Data" to enter the check weight data statistics interface, which displays product distribution intuitively. Click "Print data" to print statistics information, click "Export data" to export statistics information to the USB disk inserted into the touch screen, click "Delete data" to clear statistics information. For specific operation methods, refer to "Operation Instructions on Buttons and Operation Frames" in Section 3.3.2.

- Statistics include out of tolerance, under tolerance, the cumulative number of inspection times of qualified products, weight, average value and probability distribution, etc.
- Before testing a new batch of product, the previous statistics should be cleared, otherwise the new product will accumulate on the original statistics and generate incorrect statistics.

Data Reports		2021-10-26 11:02:39		Reserved >		
Product Name:		Standard Weight:0.000 kg				
ID: 001		Tare: 0.000 kg				
Items	Total of Number	Total of Weight	Avg.Weight			
Total:	0	0.000 kg	0.000 kg	Print Data		
Total of Qualified:	0	0.000 kg	0.000 kg			
Total of Over:	0	0.000 kg	0.000 kg	Export Data to U-disk		
Total of Under:	0	0.000 kg	0.000 kg			
Total of Unqualified:	0	0.000 kg	0.000 kg			
Total of Untreated:	0	-	-	Delete Data		
Qualify Rate: 0.00%		Max. Weight: 0.000 kg		Min. Weight: 0.000kg		
Check Datd Historical	Trend Chart	Statistical Chart	Data Statistical	NULL	Alarm Historical	EXIT

Figure 4-2 An example of the statistics page

4.3 Alarm information

Click "alarm record" to enter the interface for viewing alarm records, and you can view the alarm information in the process of weight inspection, including alarm serial number, alarm time, number and alarm content. For specific operation methods, please refer to "Operation Instructions of Button and Operation Frame" in Section 3.3.2.

Data Reports		2021-10-26 11:02:39		Reserved >	
Index	Time	Alarm	Alarm Information	<input type="text" value="0"/> <input type="button" value="Export Data to U-disk"/> <input type="button" value="Delete Data"/>	
<<		<		0/000000	
>		>>			
Check Datd Historical	Trend Chart	Statistical Chart	Data Statistical	NULL	Alarm Historical EXIT

Figure 4-3 Alarm information screen example

4.4 Statistical graph

Click "Statistical Chart" to enter the statistical chart interface to visually view the product weight distribution.

Data Reports		2021-10-26 11:02:39		Reserved >	
Total:	<input type="text" value="0"/>				
Total of Qualified:	<input type="text" value="0.00%:00"/>				
Total of Over:	<input type="text" value="0.00%:00"/>				
Total of Under:	<input type="text" value="0.00%:00"/>				
Total of Unqualified:	<input type="text" value="0.00%:00"/>				
Total of Untreated:	<input type="text" value="-. --%:--"/>				
Check Datd Historical	Trend Chart	Statistical Chart	Data Statistical	NULL	Alarm Historical EXIT

Figure 4-4 Example of the statistical chart interface

5. Quantity of switches

5.1 I/O I/O testing

System Setting		Product Name: ID: 001		<div style="font-size: 2em; font-weight: bold;">0.0</div> <div style="font-size: 0.8em;">g ppm</div>		Stopped		Reserved >	
								2021-10-26 10:02:26	
Relay-K1	Run	K1 OFF	Change	IN-DI1	Run	DI1 OFF			
Relay-K2	Stop	K2 OFF	Change	IN-DI2	Stop	DI2 OFF			
Relay-K3	Over Reject	K3 OFF	Change	IN-DI3	Clear alarm	DI3 OFF			
Relay-K4	Under Reject	K4 OFF	Change	IN-DI4	Over Reject done	DI4 OFF			
Relay-K5	Alarm	K5 OFF	Change	IN-DI5	Under Reject done	DI5 OFF			
Relay-K6	Batch Done	K6 OFF	Change	IN-DI6	Pack Gap Error Detect	DI6 OFF			
Relay-K7	OK	K7 OFF	Change						
Relay-K8	Busy&Stop	K8 OFF	Change						
				I/O Test		<input type="checkbox"/>		Next Page >	
Work Para.	I/O	Static Weight Calibration	Belt Speed Calibration	System Info.	EXIT				

Figure 5-1 I/O parameter screen Example 1

System Setting		Product Name: ID: 001		<div style="font-size: 2em; font-weight: bold;">0.0</div> <div style="font-size: 0.8em;">g ppm</div>		Stopped		Reserved >	
								2021-10-26 10:02:26	
OUT-DO1	None	DO1 OFF	Change	E-1	Input Photoelectric Sensor	E1 OFF			
OUT-DO1	None	DO2 OFF	Change	E-2	Output Photoelectric Sensor	E2 OFF			
OUT-DO1	None	DO3 OFF	Change						
OUT-DO1	None	DO4 OFF	Change						
3-Colors Buzer Lamp		Red OFF	Green OFF	Yellow OFF	Buzer OFF	Change			
< Previous Page				I/O Test		<input type="checkbox"/>			
Work Para.	I/O	Static Weight Calibration	Belt Speed Calibration	System Info.	EXIT				

Figure 5-2 I/O parameter screen example 2

Click "Switch quantity" on the setting page to enter the IO test interface. The system provides 6 input terminals and 12 output terminals, which users can decide whether to use according to production requirements. For specific operation methods, please refer to "Operation Instructions on Buttons and Operation Frames" in Section 3.3.2.

IO test is to test whether the IO port is properly connected to the external device. During the test, click "Switch" after the output to output 1-8. If the corresponding relay coil is closed (red indicator light on the relay base) and the corresponding device is in action, the connection is normal and the output point of the checkweigher is valid; otherwise, please check whether the connection between the output point and the device is correct; Click the "switch" behind the three-color light, if the three-color indicator light is on, the connection is correct.

The input test can be carried out by setting the low level signal (DC0V) at the input end. If the low level signal is effective at the corresponding input port, the test indicator box behind the corresponding input point ON the touch screen will light up and display "ON" (The photoelectric input can be blocked on the main interface when testing the photoelectric input, if the corresponding input and discharge marks are lit up, the photoelectric input is effective). The input and output signals can be defined by themselves.

The default switching quantity is defined as follows:

Enter the port number	Definition	Output port number	Definition
DI1	Run	Relay -K1	Run
DI2	Stop	Relay -K2	Stop
DI3	Clear alarm	Relay -K3	Out-of-error culling
DI4	Aberration culling complete	Relay -K4	Undercount culling
DI5	Owe culling complete	Relay -K5	Alarm
DI6	Packet detection	Relay -K6	Number of batches completed
E1	I1 (incoming photoelectric sensor)	Relay -K7	Qualified indication
E2	I2 (discharge photoelectric sensor)	Relay -K8	Disqualified cull
		DO 1	Undefined
		DO 2	Undefined

		DO 3	Undefined
		DO 4	Undefined
		L 1	O17 (Buzzer alarm output)
		L 2	O7 (alarm light out-of-tolerance indication, no relay)
		L 3	O10 (alarm light qualified indication, no relay)
		L 4	O6 (alarm light undererror indication, no relay)

List of definable switching quantities:

Enter switch quantity:

Number	Name	Function description
I00	Undefined	No function when this item is selected.
I01	Input photoelectric	When the input is valid, it means that the input photoelectric sensor has sensed the measured object
I02	Output photoelectric	When the input is valid, it means that the output photoelectric sensor has sensed the object under test
I03	Run	When the input is valid, the device will boot into the running state
I04	Stop	The device will stop running when the input is valid
I05	Clear alarm	When the input is valid, the device will clear the current alarm
I06	Aberration cull complete	When the input is valid, the offset cull is complete
I07	Owe culling complete	When the input is valid, the underbalance culling has been completed
I08	Packet detection	When the input is valid, the device performs packet connection detection
I09	Belt speed detection	

I10	Run/stop [level]	Control device operation or stop by level signal
I11	Run/stop [edge]	When the device is in the stopped state, the signal input is effective, the device starts to enter the running state; When the signal input is effective, the device stops running;
I12	Stop (level)	The signal is valid and the touch screen cannot start the device

Output switching quantity:

Number	Name	Function description
O00	Undefined	No function when this item is selected.
O01	Out-of-tolerance indication	If the weight check result is out of tolerance, the output is valid and continues until the next weight check is completed.
O02	Owe indication	If the weight check result is underweight, the output is valid and lasts until the next weight check is completed.
O03	Run	Run status output is valid.
O04	Stop	The stopped state output is valid.
O05	Alarm	Output is valid when alarming.
O06	Out-of-order culling	The weight check result is out of tolerance, according to the set out of tolerance eliminator distance delay, and then according to the set duration output valid.
O07	Owe culling	The weight check result is the undererror, according to the set offset culler distance delay, and then according to the set duration output valid.
O08	Disqualified culling	The weight inspection result is out of tolerance or undertolerance, according to the set distance delay of the unqualified eliminator, and then according to the set duration output effective.
O09	Number of batches completed	This output is valid when the set number of batches is reached.
O10	Qualifying instructions	If the weight check result is underweight, the output is valid and continues until the next weight check is completed.

O11	Busy Stop + communication	When the system is in busy state, busy detection is valid, this output is invalid, busy state is invalid and communication command is received, this output is valid, busy detection is invalid, this output is valid
O12	Busy stop	When the system is in busy state, busy detection is valid and this output is invalid, busy state is invalid, this output is valid, busy detection is invalid, this output is valid
O13	Feed photoelectric output	According to the state of the input photoelectric output, the input photoelectric effective, then the output effective.
O14	Discharge photoelectric output	According to the state output of discharge photoelectric, discharge photoelectric is effective, then the output is effective.
O15	Speed up pulse	Servo feedback function
O16	Deceleration pulse	Servo feedback function
O17	Buzzer alarm output	Output in different ways depending on your choice
O18	Qualified Cull	

6. Working parameters

6.1 Working parameter Settings

Click "Set" to enter the interface of working parameters, and the user can decide whether to open according to the production needs. If the corresponding alarm is generated after opening, the weight checking scale will automatically alarm or alarm stop. It needs to manually click "clear alarm" or input the signal of "clear alarm" to start the weight checking again (after the alarm is generated and until the clear alarm is completed, The motor of the check checkweigher runs but does not determine whether the object is on or off the weighing platform, nor does it carry out weighing operation), and the alarm information is stored in "Data" - "Alarm information". For specific operation methods, please refer to "Operation Instructions of Button and Operation Frame" in section 3.3.2.

System Setting		Product Name: ID: 001		0.0 <small>Stopped</small> g 0ppm		Reserved >		2021-10-26 10:02:26	
Over/Under Queue Full Alarm&Stop			<input type="checkbox"/>		Over/Under Alarm&Stop			<input type="checkbox"/>	
Rejector Miss Alarm&Stop			<input type="checkbox"/>		Display Over/Under in MainPage			<input type="checkbox"/>	
System Busy Alarm&Stop			<input type="checkbox"/>		Main Display Results only when Running			<input type="checkbox"/>	
Blocking Time Over Error Alarm&stop			<input type="checkbox"/>		Sub Display Real Weight			<input type="checkbox"/>	
Weighing Timeout Alarm&Stop			<input type="checkbox"/>		Continuous Packs Not Reject			<input type="checkbox"/>	
Cont. Unqualified Alarm&Stop			<input type="checkbox"/>		Photoelectric Sensor Blowing Interval Time			0 S >	
Auto ZERO Failure Alarm&Stop			<input type="checkbox"/>		Photoelectric Sensor Blowing Operating Time			0 S >	
Motor Overload Alarm&Stop			<input type="checkbox"/>		Next Page >				
Work Para.	I/O	Static Weight Calibration	Belt Speed Calibration	System Info.	EXIT				

Figure 6-1 Working parameters screen example

Analysis of working parameters:

Name	Instructions
The alarm stops when the queue is full	The default number of over/under error queue is 20, which means that if the removal distance is long enough, that is, it takes a long time for the products to be removed to arrive at the removal institution, there can be more than 20 products in the middle. If there are more than or equal to 20 over/under

	error products to be removed in this distance, it will alarm and stop
If not eliminated in time, the alarm will be stopped	After the next unqualified product has gone through the reinspection process, the last product has not been removed, the alarm will be stopped
Busy alarm stop	In the last product has not been out of the inspection belt, the next product into the inspection belt, it will show busy alarm and stop.If the back end is connected with an over and under error elimination mechanism, the default is over error elimination
The time of overplugging will alarm and stop the machine	Indicates that if the discharge photoelectric induction continues, and exceeds the plugging time set in the system parameter interface, it will alarm and stop
If the maximum time on the scale is exceeded, it will alarm and stop	There are two kinds of action;1. If the maximum time on the scale set on the touch screen is more than 2 times of the time required for the object to pass the scale, the maximum alarm time on the scale is twice of the time required for the object to pass the scale. 2. If the maximum time on the weighing platform set on the touch screen is less than or equal to twice the time required for the object to pass the weighing platform, the maximum alarm time on the weighing platform is the maximum time on the weighing platform set on the touch screen
The number of consecutive unqualified alarms	The number of consecutive failed alarms
The number of super continuous disconformance alarm stops	In the product parameter setting interface, you can set the alarm number of continuous nonconformance. If the set value is not zero and the switch is on, the number of continuous nonconformance will alarm and stop when it reaches this value

Upper limit of motor load	The maximum load the motor can withstand
Stop above the motor load limit	The upper limit of motor load can be set in the system parameter interface of the product. When the weight of the product or the object to be weighed exceeds the set upper limit, it will alarm and stop
Overweight or underweight alarm and stop	Display on the main page that the result of this test product is out of tolerance or under tolerance and the device will stop.If you need to use this function, you need to move forward the discharge photoelectric position, please contact our technical department for details
The main page displays the information of overshoot and undershoot	On the main page, it shows that the result of this test is out of tolerance, under tolerance, or qualified
The main page will display only the weight test result	Only the product weight test result of this test is displayed on the main page
Auxiliary display of real-time weight	Display the detected real-time product weight on the main page
Units	g/kg/t Optional
Minimum indexing	0.001. 0.002. 0.005. 0.010. 0.020. 0.050 Optional
Check scale for stability range	When calibrating the scale, the weight variation range is judged to be stable within this setting value
Judge the range of stability;	During the stabilization time, the range of weight variation is judged to be stable within this setting value

Zero tracking range	Weight value within this range, automatically clear zero
Clear range	The range at which the scale table is zeroed out during weighing
Automatic zeroing at startup	Perform zero clearing once the scale platform is started
Check the maximum judgment time of the scale	Is the longest judgment time in the process of weight calibration, indicating that the weighing platform must be stable and the zero voltage must be within the limited range during the calibration of the empty weighing platform and the weight calibration process. If the above conditions are not met and the maximum judgment time is exceeded, the alarm will be given and the weighing will fail
Decimal point	0 0.0 0.00 0.000 0.0000 Optional
Maximum range	100G
Check scale for stability time	When checking the scale, the range of weight variation is judged to be stable within the stability range of the scale
Stabilizing time	Within this setting, the range of weight variation is judged to be stable within the range of stability
Zero tracking time	During this time, the system data drift does not exceed the zero tracking range
The system automatically clears zeros after power-on	Zero clearing operation will be performed once on the scale platform
Feed to shake time	Do not sample during this time after feeding
Time to remove shaking from material	Do not sample during this time before discharging
Length of scale table	800mm

Maximum time on the scale table	Maximum time an item is on the scale
Material blocking time	From the discharge photoelectric induction to the material time, more than this time alarm
Dynamic zero clearance range	Range of zeroing of the weighing platform during the weight checking process
Digital filtering level	0 to 9 can be set
AD sampling rate	120 beats per second 240 beats per second 480 beats per second
Pre-filter grade	0 to 20 optional
Time between photoelectric dust removal	When the system runs to the set value, the photoelectric dust removal begins
Duration of photoelectric dust removal	The output time of the photoelectric dust removal switch
Buzzer buzzer type	There are four types to choose from, which are undererror, out-of-error, unqualified, and qualified
Buzzer sounding mode	There are three ways to choose from, long buzzer, off, and delay
Buzzer delay time	The delay time is 0.000-10.000S
Over/Under Alarm Popup Window	The pop-up window displays the alarm information when the error is not suspended
Over/Under Alarm Recorded	Over/under tolerance alarm is recorded in alarm record

7. Communication

The product has RS485 and optional network port for external communication. The communication protocol is standard Modbus RTU, and the network port communication includes Modbus TCP/IP and HTTP. When the communication mode is printed, RS485 can be connected to the printer for printing output. For detailed operation methods, refer to "Operation Instructions on Buttons and Operation Frames" in section 3.3.2.

7.1 Communication parameters

Click "Setting" to enter the interface of working parameters, and then click the next page. The user can set the communication mode of the serial port to realize the communication between the checkweigher and the external control unit such as the upper computer or connect the printer.

System Setting		Product Name: ID: 001		0.0 <small>Stopped</small> <i>g</i> <small>0ppm</small>		Reserved >		2021-10-26 10:02:26	
< Previous Page									
COM1 Mode			Modbus-RTU >		COM2 Mode			Modbus-RTU >	
Slave ID			001 >		Slave ID			001 >	
BAUD			57600 >		BAUD			57600 >	
Byte Format			8-E-1 >		Byte Format			8-E-1 >	
Dword Data Format			AB-CD >		Dword Data Format			AB-CD >	
					Next Page >				
Work Para.	I/O	Static Weight Calibration	Belt Speed Calibration	System Info.	EXIT				

Figure 7-1 Communication parameters interface Example 1

System Setting		Product Name: ID: 001		0.0 Stopped g 0ppm		Reserved >		2021-10-26 10:02:26	
< Previous Page									
COM3 Mode			Modbus-RTU >		LAN Mode			Modbus-TCP/IP >	
Slave ID			001 >		IP			192 · 168 · 071 · 101	
BAUD			57600 >		Port			502 >	
Byte Format			8-E-1 >		LAN MAC			BC AA BB CC 01 02	
Dword Data Format			AB-CD >						
					Next Page >				
Work Para.	I/O	Static Weight Calibration	Belt Speed Calibration	System Info.	EXIT				

Figure 7-2 Communication parameters screen Example 2

Description of communication parameters:

Name	Instructions
Serial communication method	Modbus-RTU
Mailing address	The address of the current device
Baud rate	Baud rate for current device communication
Byte format	The byte format of the current device communication. Default 8-E-1
High and low bytes	Bytes of current device communication. Default AB-CD
Network port communication mode	Network port communication mode
IP address	IP address for current device communication
Port number	Port number for current device communication
MAC address	MAC address for current device communication

7.1.1 Serial port communication

The checkweigher is configured with three serial ports, which can communicate with the host computer through RS485 serial ports. The optional functions are Modbus-RTU and print mode (serial port three can only be set as print). The data format 7-E-1 is fixed as print, and Modbus-RTU communication cannot be carried out.

Serial number	Range	Instructions
Mailing address	1 to 245	Check the weight scale slave number
Communication method	Modbus-RTU, print	Communication Modes and functions
Baud rate	9,600, 19,200, 38,400, 57600 and 115,200	Communication data transfer speed
Data format	7-E-1(Print), 8-e-1, 8-n-1.	Communication transmission data Format
High and low bytes	High word first or low word first	Facilitate communication of various upper computers

When the host computer communicates with multiple checkweighers at the same time, the code of each checkweigher device cannot be consistent, and the maximum value is 245 (that is, a single PC can be connected to 245 checkweighers at the same time).

7.1.2 Network port communication

The checkweigher can communicate with the host computer through a 10M/100M adaptive network port. The optional functions are Modbus TCP/IP and HTTP protocol. Parameter setting requirements are as follows:

Serial number	Instructions
IP	The upper computer and the motherboard must be in the same network segment and not equal
Port number	Range 0-65535, usually set to 502 for slave
MAC address	The address of each device cannot be repeated and is set before delivery

HTTP works in server-side mode, and the protocol is as follows:

- 1 Send: http://IP,
Return: current weigh value (screen display value).
For example:
Send to: http://192.168.61.223
Return: 123.456kg
- 2 Send:
http://IP/szgmt.html
Return: Current weighing value (screen display value).
For example:
Send: http://192.168.10.15/szgmt.html
Return: 123.456kg
- 3 Send:
http://IP/cwrf.html
Return: Current weigh value (screen display value), new weigh data identification.
For example:
Send: http://192.168.10.15/cwrf.html
Return: 123.456kg0 (This value changes from 0 to 1 or from 1 to 0 when there is a new check result)
- 4 Send:
http://IP/crf.html
Return: New weigh data identification.
Example:
Send to: http://192.168.10.15/crf.html
Return: 1 (change the value from 0 to 1 or from 1 to 0 when there is a new check result)

7.1.3 MAC address

The MAC address is the physical address of the checkweigher and cannot be modified. It represents the identification number of the checkweigher.

7.2 The Modbus register communication address is defined

PLC address	Module address	Parameter definition	Remarks	
Home screen status (Support function code 0x03)				
40001	0000	Module current status 1	. 0	1: Weight positive overflow
			1.	1: The sensor is overflowing
			2.	1: Weight negative overflow

			3.	1: Negative sensor overflow
			4.	1: Weight plus or minus identifier bit 0: plus 1: minus
			5.	1: zero point identifier bit
			6.	1: Stabilize the identifier bit
			...	reserve
			12.	1: Static calibration state
			13.	1: Zero point calibration is successful
			14.	1: Gain calibration is successful
			15.	Reservations
40002	0001	Module current status 2	0.	1: Run 0: Stop
			1.	1: Upper limit (for indication)
			2.	1: Lower limit (for indication)
			3.	1: Qualified (for indication)
			4.	1: out of tolerance (for culling)
			5.	1: Underbalance (for culling)
			6.	1: Qualified
			7.	1: Busy (for indication)
			8.	1: IO test
			9.	1: Belt calibration
			10.	1: Dynamic calibration
			11.	1: Feed
			12.	1: Discharge
			13.	1: Keep
14.	1: Return to zero			

			... reserve
40007	0006	Weight value	Stop status: real-time weight;Running state: weight check result
40008	0007		
40539	0538	Out-of-tolerance ratio	
40540	0539		
40541	0540	Underdifference ratio	
40542	0541		
40551	0550	Error number	1: Busy
			2: Not removed in time
			3: Continuous disqualification
			4: Total batch completed
40552	0551		5: Qualified batch completed
			6: Block the material
			There is no
			8: Super maximum sampling time
			9: Super motor load
40563	0562		Actual weight check speed
40564	0563		
Product parameters (Function codes 0x03, 0x10 supported.)			
40101	0100	Product number	Read: Currently selected product number;Write: Write needs to select the product number and update to write value after writing
40102	0101		
40103	0102	Product weight	Static weight of the product to be checked
40104	0103		

40105	0104	Upper limit	Allowable upper deviation of product conformity
40106	0105		
40107	0106	Lower limit	The permissible lower deviation of product conformity
40108	0107		
40109	0108	Pack weight	Package weight that is weighed with the product but does not count towards the result
40110	0109		
40215	0214	Total lot	Quantitative production inspection weight total production;0 ~ 999999pcs
40216	0215		
40217	0216	Qualified lot	Quantitative production of qualified products;0 ~ 999999pcs
40218	0217		
40279	0279	Photoelectric dusting cycle	Initial value: 60, range: 60 to 1800
40280	0280		
40281	0281	Photoelectric dust removal time	Initial value: 1, range: 1 to 10
40282	0282		
Statistics (Support function code 0x03)			
40501	0500	Qualifying cumulative count	
40502	0501		
40503	0502	Qualified cumulative weight	
40504	0503		
40505	0504	Cumulative number of out-of-bounds	
40506	0505		
40507	0506	Out of tolerance accumulated weight	
40508	0507		
40509	0508		

40510	0509	Cumulative number of owes	
40511	0510	Accumulated weight of underweight	
40512	0511		
40513	0512	Cumulative number of disqualifications	
40514	0513		
40515	0514	Disqualified accumulated weight	
40516	0515		
40517	0516	Total cumulative times	
40518	0817		
40519	0518	Total accumulated weight	
40520	0519		
40521	0520	Maximum	
40522	0521		
40523	0522	Minimum	
40524	0523		
40527	0526	Pass rate	
40528	0527		
40529	0528	All qualified products are heavy	
40530	0529		
40531	0530	Average weight of out- of-tolerance products	
40532	0531		
40533	0532	Underweight products average weight	
40534	0533		
40537	0536		

40538	0537	Total cumulative average weight	
40559	0558	Check weight result reading identifier (0, 1 change)	When the read value changes from 0 to 1, or from 1 to 0, the proof read value is updated data.
40560	0559		(When power-on, the value is fixed at 3, stop and alarm is 2. When HMI programming, according to the change of value jump collection, attention should be paid to adding the judgment that is not equal to 2 or 3)
40561	0560	Weight check result	Read as the result value of this test weight, when there is a new test result, the value will be updated.
40562	0561		
The following is readable bit status (read function code 0x01, write function code 0x05)			
00001	0000	Weight positive overflow	
00003	0002	Weight negative overflow	
00005	0004	Weight plus and minus sign	
00006	0005	Zero mark	
00007	0006	Stable sign	
00008	0007	Keep signs	
00011	0010	Qualifying mark	
00012	0011	Underage sign	
00013	0012	Out-of-tolerance sign	
00014	0013	busy	
00015	0014	Call the police	
00016	0015	Batch times to	

00031	0030	Run (when writing ON, start running, stop running when writing OFF)
00032	0031	Zero clear (when writing ON, zero clear)
00033	0032	Clear alarm (Clear alarm when there is an alarm written ON)
00034	0033	Print (when writing ON, print out)

7.3 Print content

1. When the communication mode is set to print, connect the printer, click the print button on the "Statistics" interface, or send the print command through the communication mode, the output will be as follows:

```

-----
DATE:          2015.10.15
TIME:          15:21
PRODUCT CODE:  1
TARE WT:       0.000kg
UP LIM:        0.030kg
REF WT:        8.135kg
LOW LIM:       0.030kg
PASS CT:       1
PASS WT:       8.140kg
PASS AVR:      8.140kg
PASS RATE:    100.00%
OVER CT:       0
OVER WT:       0.000kg
UNDER CT:      0
UNDER WT:      0.000kg
TOTAL CT:      1
TOTAL WT:      8.140kg
MIN WT:        8.140kg
MAX WT:        8.140kg
-----
    
```

2. When the communication mode is set to result printing, the device will actively send data. After each check, it will actively send the content shown in the following figure through the serial port:

20140503142100 0.0346kg

The format is timestamp+weight. If there is an external printing device, the above content will be printed. The above content is only an example. The specific printed data is subject to the actual test results.

3. The data format of CHRE mode is as follows:

S T X	leave a blank space	status	Leave a blank space	sign	limit	leave a blank space	Sampling results	unit	CRC	CR	LF
-------------	------------------------------	--------	------------------------------	------	-------	------------------------------	---------------------	------	-----	----	----

Among:

(1) STX —— Start character, (02H) .

(2) status ——3 bit, In case of alarm, state 1 is "E" (45H), state 2 and state 3 are error identifications, otherwise all three bits are spaces 20H.

(3) sign —— 1 bit. Each time there is a new sampling mean, the data mark is added by 1, from 30H to 39H, and then back to 31H. Used for auxiliary extraction of sampling data.

(4) limit —— 1 bit is the limit of the current sampling value. The upper limit of the sampling value is "H" (48H). If the sampling value is qualified, it is "G" (47H). If the lower limit of the sampling value is "L" (4CH).

(5) Sampling results —— 7-digit weight data (including 6-digit content, 1-digit decimal point (2EH), if there is no decimal point, the high digit is 20H).If the weight value is 3.75, it is 30H 30H 30H 33H 2EH 37H 35H.

(7) Unit - 2 digits, "kg (6BH 67H)" for kilogram and "g (67H 20H)" for gram.

(8) CRC - is a checksum, which means that all preceding values are added and converted to decimal, and then the last two digits are taken and converted to ASCII code.

(9) CR - return sign (0DH).

(10) LF -- Line feed sign (0AH).

7.4 Set the parameters of the servo driver

1. Use a digital operator to set the input motor driver, weight check motor driver, and reject motor driver parameters F5.03 to 1, 2, and 3, respectively.

2. If the motor reverses after operation, use a digital operator to modify parameter F1.01 to 0.

8. Program upgrade

The device can upgrade the motherboard program and touch screen program through the way of U disk. For details, please refer to "Operation Instructions on Buttons and Operation Frames" in section 3.3.2.

System Setting		2021-10-26 11:02:39		Reserved >	
Device Model	CW-600G-101B >	Cal Para. Reset	I/O Define Reset		
Work Model	Check Model >				
Language	ENG[ENG]	Product Para. Reset	Work Para. Reset		
HMI Version: 00.01.05 Time: 2021/08/02 08:00:30 MainBoard Version: 0.00.00 Time: 2021/08/02 08:00:30 Mainboard Upgrade With U-disk					
		Communication parameter reset	Belt Para. Reset		
		All Para. Reset	Setting Date/Time		
Work Para.	I/O	Static Weight Calibration	Belt Speed Calibration	System Info.	EXIT

Figure 8-1 System Information screen example

After contacting our technical department, confirm that it is necessary to upgrade the program of the motherboard or touch screen. Obtain the corresponding program upgrade package first. Insert the USB flash drive with the upgrade package, click the "USB flash Drive Upgrade Controller" button to enter the upgrade interface, and perform the corresponding program upgrade according to the interface instructions. It is suggested to upgrade the program of the equipment under the guidance of our technical personnel, so as to avoid equipment failure or damage.

9. Size

When the equipment is installed on site, it is necessary to ensure that there is no contact between the weighing table and the surrounding area to avoid affecting the normal weighing. The distance between the surrounding area of the weighing table should be greater than 10mm.

9.1 Outline size drawing (unit: mm)

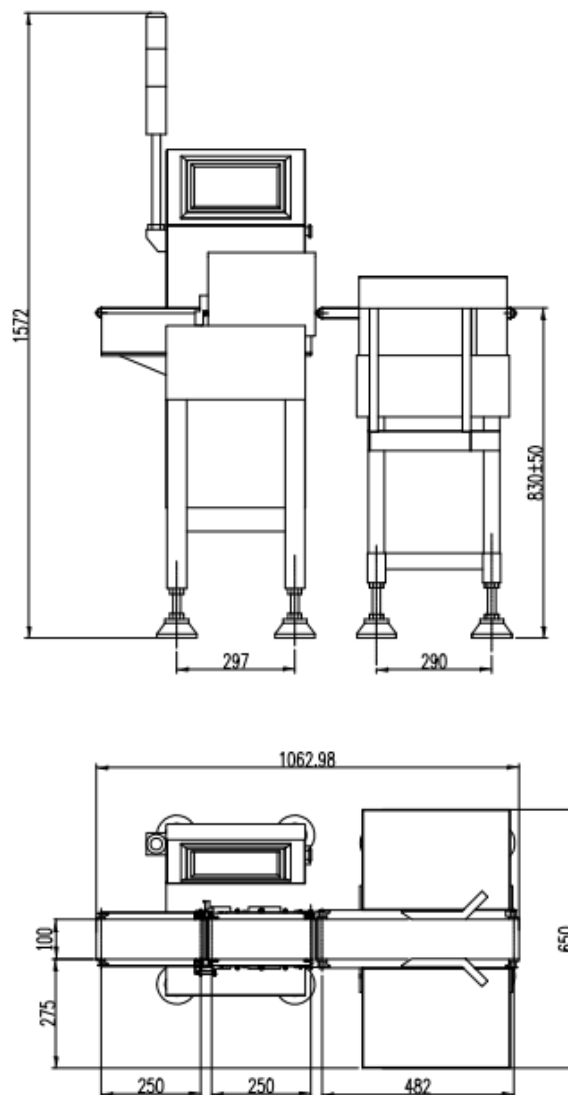

*** Note: The width, length and height of the scale stand of non-standard customized products may be different from that of the standard products. For details, please refer to the technical documents or drawings confirmed by the user.**

10. Equipment repair and maintenance

10.1 Maintenance of motors

10.1.1 Routine maintenance

- Keep the motor clean and prevent oil, water and other dirt from entering the motor.
- Check motor terminal bolts and motor base fixing bolts for loosening
- Check the rotation of the motor blades
- Check whether the bearings at both ends of the motor have oil leakage and other phenomena
- Pay attention to observe whether there is abnormal noise, vibration and special smell in the operation of the motor.

10.1.2 Regular maintenance

- For normal operation of the motor, the mechanic and maintenance electrician shall carry out the maintenance once a year.
- Remove dust or debris inside the motor (be careful not to damage the winding of the motor)
- Check whether the rotor of the motor is flexible and replace the wearing parts (bearings, etc.)
- Check the insulation resistance of the motor windings to the ground. When the insulation resistance is below $0.5M\Omega$, the motor must be dried.
- Replace the grease.
- Check whether the no-load current is within the specified range

10.1.3 Precautions

- In the process of maintenance, attention should be paid to the safety of electricity and mechanical transmission, and illegal operation is strictly prohibited.
- When installing the repaired or replaced motor, attention should be paid to the wiring mode, and attention should be paid to whether the motor rotation direction is consistent with the reality.
- After installation, the motor should be clicked, and pay attention to observe whether the motor runs normally.

10.2 Check the failure cause and treatment method of weight scale

10.2.1 No display on the touch screen

- Method of Handling poor Power contact Connect the power cable
- Loose or falling data cable treatment method Connect the data cable

10.2.2 Data pulsation large, abnormal fluctuation

- Handling Method for loose screws of the heavy machine pedestal Tighten the screws of the heavy machine pedestal

- The sensor is obviously disturbed, such as air conditioning, air flow, etc. Disposal method to get rid of external interference
- Ground shaking, vibration, such as nearby machine rotation interference, cars passing by, etc. Treatment methods to get rid of external interference
- The conveyer belt is affected by viscous objects
- Sensor base has debris accumulation or stuck processing method to get rid of external interference
- Filter coefficient set too small processing method to increase the filter coefficient

10.2.3 The display is always zero

- The object is light and the weight falls in the zero range. The treatment should be resolved by resetting the "zero range".
- Device trace to zero. The handling method can be solved by adjusting the "automatic zero tracking" item in the calibration option of the system.
- The sensor data cable is loose, and the contact is not good. Solution Connect the sensor data cable properly

10.2.4 Abnormal data display

- The error is too large. Handling Method Recalibrate the scale.
- Product number selection error. The handling method should be resolved by clicking "Switch Product" again and selecting the corresponding companion product number.
- The ambient temperature exceeds the normal operating range of the sensor. Ensure that the ambient temperature is normal
- Aging or deformation of sensor components. Solution Replace the sensor

10.2.5 Busy alarm

- After the object into the material is not out of the weighing platform, and there are objects on the weighing platform. Handling Method Adjust the feeding speed, the material out of the weighing platform before allowing the next material on the weighing platform.

10.2.6 Packaging error

- Remove too many unqualified products in time. Handling method Eliminate unqualified products in time.

10.2.7 Continuous nonconformity alarm

- The number of consecutive disqualifications exceeding the set value. Alarm prompt, no need to deal with the weight check work normally.

10.2.8 Excess plugging time

- During operation, the object stays too long at the feeding or discharging end. Solution Check the reason for the object staying time is too long and deal with it in time.

10.2.9 Below the minimum sampling time

- The object is coming off the scale too quickly in operation. Adjust the speed of the belt of the weighing table within the detectable range.

10.2.10 Super maximum sampling time

- Long period of time when the object in operation is not off the scale. Check the reason why the object is not out of the weighing table for a long time and deal with it in time.

10.2.11 Overload motor load limit

- The weight of the object exceeds the maximum range by a certain amount (exceeds the maximum weight of the motor). Handling Methods Do not weigh objects beyond the maximum range.

10.2.12 Automatic zeroing failed

- 1. The current weight is out of the zero clearance range.
- 2. The scale is unstable. Treatment Method 1 Empty the scale table 2 Make sure the scale is stable